

COMMERCIAL PRODUCT CATALOGUE





ABOUT US

Vinaayak Enterprise - Manufactures & Traders of Commerical Kitchen Equipment

Founded in 2003 by Vinitt Aggarwal, Vinaayak Enterprise has emerged as a trusted name in the manufacturing and trading of commercial kitchen equipment. With over two decades of experience, we have been committed to delivering innovative, high-quality solutions that cater to the diverse needs of the food and hospitality industry.

Our journey began with a vision to revolutionize the way commercial kitchens operate, ensuring efficiency, durability, and superior performance in every product we offer. Today, Vinaayak Enterprise stands as a leader in the industry, known for our cutting-edge technology, exceptional craftsmanship, and unwavering dedication to customer satisfaction.

We specialize in a wide range of kitchen equipment, from robust industrial ovens and high-capacity refrigerators to precision-engineered cookware and custom-built installations. Our products are designed to meet the rigorous demands of professional kitchens, helping chefs and kitchen staff achieve excellence in every dish they prepare.

At Vinaayak Enterprise, we believe in continuous innovation, staying ahead of industry trends, and always striving for excellence. Our commitment to quality is reflected in every product we manufacture, ensuring that our clients receive nothing but the best.

Under the leadership of Vinitt Aggarwal, our team of skilled engineers, designers, and craftsmen work tirelessly to uphold the high standards that Vinaayak Enterprise is known for. We take pride in our ability to deliver customized solutions that not only meet but exceed our clients' expectations.

TABLE OF CONTENT

Hot Equipment	PAGE 2-5
Prep Equipment	PAGE 6-8
Exhaust Hood	PAGE 9
Work Table & Sink	PAGE 10-11
Trolley & Others	PAGE 12
Cold Equipment	PAGE 13-20
Bakery Equipment	PAGE 21-25
Imported Equipment	PAGE 26-43



TILTING BRATT PAN INDUCTION

MODEL	VE-TBP-100(i)	VE-TBP-150 (i)	VE-TBP-200 (i)	VE-TBP-300 (i)
Capacity	100L	150L	200L	300L
Dimension	1200 x 900 x 1000	1350 x 1000 x 1000	1350 x 1000 x 1000	1650 x 1000 x 1000
Electric Load	10 Kw	15 Kw	20 Kw	30 Kw
Voltage	380v/50Hz	380v/50Hz	380v/50Hz	380v/50Hz
Water Inlet	Yes	Yes	Yes	Yes
Material	SS-304/430	SS-304/430	SS-304/430	SS-304/430
Tilting Provision	Yes	Yes	Yes	Yes

● *40% faster cooking*

● *50% economical*

● *90% safe*

TILTING BRATT PAN (GAS)

MODEL	VE-TBP-100 (G)	VE-TBP-150 (G)	VE-TBP-200 (G)	VE-TBP-300 (G)
Capacity	100L	150L	200L	300L
Dimension	1200 x 900 x 1000	1350 x 1000 x 1000	1350 x 1000 x 1000	1650 x 1000 x 1000
Gas	Lpg / Png	Lpg / Png	Lpg / Png	Lpg / Png
Water Inlet	Yes	Yes	Yes	Yes
Material	SS-304	SS-304	SS-304	SS-304
Tilting Provision	Yes	Yes	Yes	Yes

TILTING BOILER

DESCRIPTION

Tilting Boiling Pan has been some of the well acclaimed and genuinely tested ranges of our firm procurable under the best of norms and policies.



TILTING BOILER INDUCTION

MODEL	VE-TB-100 (i)	VE-TB-150 (i)	VE-TBP-200 (G)	VE-TB-300 (i)
Capacity	100L	150L	200L	300L
Dimension	1200 x 900 x 1000	1250 x 1000 x 1000	1350 x 1000 x 1000	1650 x 1000 x 1000
Electric Load	10kw	15kw	20kw	30kw
Voltage	380v/50Hz	380v/50Hz	380v/50Hz	380v/50Hz
Water Inlet	Yes	Yes	Yes	Yes
Valve Dia	50mm	50mm	75mm	75mm
Material	SS-304/430	SS-304/430	SS-304/430	SS-304/430
Tilting Provision	Yes	Yes	Yes	Yes

● 40% faster cooking

● 50% economical

● 90% safe

TILTING BOILER PAN (GAS)

MODEL	VE-TBP-100 (G)	VE-TBP-150 (G)	VE-TBP-200 (G)	VE-TBP-300 (G)
Capacity	100L	150L	200L	300L
Dimension	1200 x 900 x 1000	1250 x 1000 x 1000	1350 x 1000 x 1000	1500 x 1000 x 1000
Gas	Lpg / Png	Lpg / Png	Lpg / Png	Lpg / Png
Water Inlet	Yes	Yes	Yes	Yes
Valve Dia	50mm	50mm	75mm	75mm
Material	SS-304	SS-304	SS-304	SS-304
Tilting Provision	Yes	Yes	Yes	Yes

ABOUT THE PRODUCT

KEI's Automatic Cook Wok is widely applied to daily use in central kitchens, food & beverage distribution centre, food processing factory, sauce processing factory and sweets manufacturing factory. The machine is fully made of SS 304 and the rotating arm which touches the food is made of High quality PP which is food Gradable.

KEI's Cook Wok saves a lot of labour cost and its fast convenient ways also ensures safety. The food prepared in cook wok is evenly cooked and maximises its taste as the rotating arm ensures no mixing dead zone in the boiler.



 **Environment Friendly**

COOK WOK / COOKING (INDUCTION)

MODEL	VE-CW-200 I-(MT)	VE-CW-300 I-(MT)	VE-CW-400 I-(MT)
Capacity	200L	300L	400L
Dimension	1800 x 1000 x 900+600	1800 x 1300 x 900+600	2200 x 1300 x 900+600
Electric Induction Load	20kw	30kw	40kw
Voltage	380v/50Hz	380v/50Hz	380v/50Hz
Water Inlet	Yes	Yes	Yes
Material	SS-304/430	SS-304/430	SS-304/430
Tilting Type	Motorised Tilting	Motorised Tilting	Motorised Tilting
Total Load	21.85 kw	31.85 kw	42 kw

● **40% faster cooking**

● **50% economical**

● **90% safe**

COOK WOK / COOKING (GAS)

MODEL	VE-CW-200 G-(MT)	VE-CW-300 G-(MT)	VE-CW-400 G-(MT)
Capacity	200L	300L	400L
Dimension	1800 x 1000 x 900+600	1800 x 1300 x 900+600	2200 x 1300 x 900+600
Electric Motor	1.85kw	1.85Kw	2Kw
Voltage	380v/50Hz	380v/50Hz	380v/50Hz
Water Inlet	Yes	Yes	Yes
Material	SS-304/430	SS-304/430	SS-304/430
Tilting Type	Motorised Tilting	Motorised Tilting	Motorised Tilting
Gas	LPG/PNG	LPG/PNG	LPG/PNG

MANUAL COOKING MIXTURE

ABOUT THE PRODUCT

KEI Cook-wok's method aided by its unique mixing tool and technology makes cooking easier.

Large volume cooking can be done easily and with less power usage. SS Stove with Auto Igniter & SS 304 body, Single Layer Bowl, Lid & Mixing Arm with SS Planetary Head Assembly, combination of all makes this machine a commercial beast.



MANUAL COOK WOK (GAS)

MODEL	VE-CW-200 G-(M)	VE-CW-300 G-(M)	VE-CW-400 G-(M)
Capacity	200L	300L	400L
Dimension	1400 x 1250 x 1000+1000	1600 x 1500 x 1000+1000	1850 x 1500 x 1000+1000
Gas	LPG/PNG	LPG/PNG	LPG/PNG
Water Inlet	Yes	Yes	Yes
Material	SS-304	SS-304	SS-304
Tilting Type	Manual	Manual	Manual



ABOUT THE PRODUCT

"Our vegetable washer is competent to save more than 60% of the water in comparison of the leading manufacturers in our industry.

The washer itself includes all the necessary measures to safe guard the operator such as Sealed Top cover, Water proof Switches with Emergency Stop Function"

"Industrial Standard SS304 complete structure"

*"Washing of pan collars,
all nozzles are made of stainless steel 304"*

"More then 60% Water saving"

*"Washing container is made of SS 304(food grade)
with all plumbing, drainage connections"*

"Makes vegetable washing 10 X easier"

*"Hydraulic tilting mechanism for
ease of unloading of contents"*

"Industrial standards components"

VEGETABLE WASHER (TILTING TYPE)

MODEL	VE-TVW - 300	VE-TVW - 500
Tank Capacity	300L	500L
Capacity / Lot	50 kg	100 Kg
Overall Size	1400 x 1000 x 850mm	1825 x 1000 x 850mm
Water Inlet	1"	1"
Water Outlet	50mm	50mm
Total Electrical Load	1.5kw	2kw
Voltage	440v/3Ph	440v/3Ph
Control Panel	Front	Front
Basket Size	925 x 700 x 575mm	1225 x 700 x 575mm

POTATO PEELER



POTATO PEELER (ECONOMICAL SERIES)

MODEL	VE-PP-10	VE-PP-20	VE-PP-30
Capacity	10kg	20kg	30kg
Efficiency	200-300 kg/Hr	500-600 kg/Hr	800-1000 kg/Hr
Power	1hp	2hp	2hp
Voltage	220v	220v	220v
Dimension (mm)	500 x 500 x 800	600 x 600 x 850	600 x 600 x 1000
Water Inlet	Yes	Yes	Yes



POTATO PEELER (PREMIUM SERIES)

MODEL	VE-PP-10 (ps)	VE-PP-20 (ps)	VE-PP-30 (ps)
Capacity	10kg	20kg	30kg
Efficiency	300-500 kg/Hr	600-800 kg/Hr	1200-1500 kg/Hr
Power	1hp	2hp	2hp
Voltage	220v	220v	220v
Dimension (mm)	500 x 500 x 800	600 x 600 x 850	650 x 650 x 1000
Water Inlet	Yes	Yes	Yes

ABOUT THE PRODUCT

An all-in-one multi-functional veg-cutter to slice, chop, dice or julienne vegetables and greens. Comes with a belt feed and hopper feed system at opposite ends which can be used simultaneously. Special Vegetable Belt Cutting cum Dicing Machine delivered with SS Guide. SS Finish fitted with a Conveyor Belt for Slicing application controlled by Inverter and has Cast Alloy Feeder for Dicing inbuilt in the machine.



MULTI FUNCTIONAL CONVEYOR VEGETABLE CUTTER

MODEL	VE-M-CVC-1000
Capacity	800-1200kg / per hr*
Power	1.75kw
Voltage	220v/1ph
Dimension	1200 x 600 x 1100mm
Material	Stainless Steel

*Hard Skin Vegetable 800-1200 kg / per hr.

*Green leaves Vegetable 400-600 kg / per hr.



CONVEYOR VEGETABLE CUTTER

MODEL	VE-CVC-800
Capacity	600-800 kg/per hr*
Power	0.75 kw
Voltage	220v/1ph
Dimension	900 x 600 x 1100mm
Material	Stainless Steel

*Hard Skin Vegetable 600-800 kg / per hr.

*Green leaves Vegetable 200-300 kg / per hr.

EXHAUST HOOD

HOOD SYSTEM OVERVIEW

"Our Type 1 Exhaust Hood only commercial kitchen Type 1 is designed to remove grease laden vapours. The exhaust hoods equipped with our centrifugal up blast fans or blowers will significantly reduce odours and improve the indoor air quality inside your kitchen.



SS EXHAUST HOOD WITH FRONT TROUGH FRESH AIR SYSTEM AND SS CYCLONE FILTERS

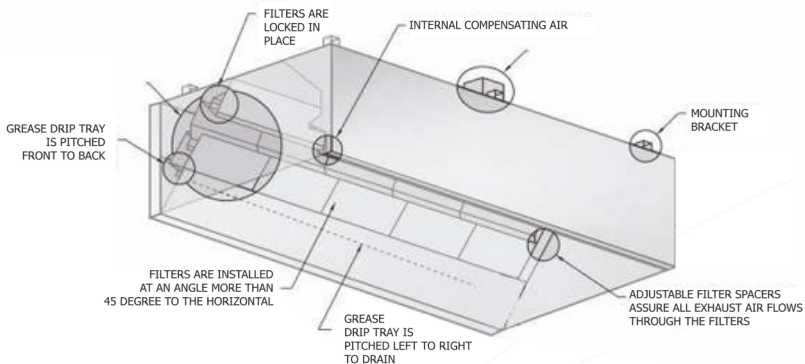

ADVANTAGE

- *Stainless steel 304*
- *Thickness 1.0/1.2mm*
- *65 LUX Lights*
- *Removable Grease Collector Tray*

The Exhaust hood is fabricated from 18 swg 304 grade stainless steel sheet. All visible surfaces are ultra fine grain polished to 320 grit. Exhaust hood is cut, punched and folded into sub section of up to 3000mm in length and factory assembled by means of computer controlled seam welds and non mechanical fixings. Joints are provided with internal cover plates so that no joints or mechanical fixing are visible. All metal edges are rolled smoothly and are free from sharp edges and projections. The Exhaust hood lower edge is formed into a full parameter condensation channel with inclined internal elevation to simplify cleaning and the inner edges are crush folded for safety purposes.



WORK TABLE WITH SINGLE UNDER SHELVE

600 SERIES

CODE	DESCRIPTION	DIMENSION (MM)
VE-WT1U/S6-900	Work Table with 1 U/S	900 x 600 x 850 + 150
VE-WT1U/S6-1050	Work Table with 1 U/S	1050 x 600 x 850 + 150
VE-WT1U/S6-1200	Work Table with 1 U/S	1200 x 600 x 850 + 150
VE-WT1U/S6-1350	Work Table with 1 U/S	1350 x 600 x 850 + 150
VE-WT1U/S6-1500	Work Table with 1 U/S	1500 x 600 x 850 + 150
VE-WT1U/S6-1800	Work Table with 1 U/S	1800 x 600 x 850 + 150
VE-WT1U/S6-2100	Work Table with 1 U/S	2100 x 600 x 850 + 150
VE-WT1U/S6-2400	Work Table with 1 U/S	2400 x 600 x 850 + 150

WORK TABLE WITH TWO UNDER SHELVE

600 SERIES

CODE	DESCRIPTION	DIMENSION (MM)
VE-WT2U/S6-900	Work Table with 2 U/S	900 x 600 x 850 + 150
VE-WT2U/S6-1050	Work Table with 2 U/S	1050 x 600 x 850 + 150
VE-WT2U/S6-1200	Work Table with 2 U/S	1200 x 600 x 850 + 150
VE-WT2U/S6-1350	Work Table with 2 U/S	1350 x 600 x 850 + 150
VE-WT2U/S6-1500	Work Table with 2 U/S	1500 x 600 x 850 + 150
VE-WT2U/S6-1800	Work Table with 2 U/S	1800 x 600 x 850 + 150
VE-WT2U/S6-2100	Work Table with 2 U/S	2100 x 600 x 850 + 150
VE-WT2U/S6-2400	Work Table with 2 U/S	2400 x 600 x 850 + 150

700 SERIES

CODE	DESCRIPTION	DIMENSION (MM)
VE-WT1U/S7-900	Work Table with 1 U/S	900 x 700 x 850 + 150
VE-WT1U/S7-1050	Work Table with 1 U/S	1050 x 700 x 850 + 150
VE-WT1U/S7-1200	Work Table with 1 U/S	1200 x 700 x 850 + 150
VE-WT1U/S7-1350	Work Table with 1 U/S	1350 x 700 x 850 + 150
VE-WT1U/S7-1500	Work Table with 1 U/S	1500 x 700 x 850 + 150
VE-WT1U/S7-1800	Work Table with 1 U/S	1800 x 700 x 850 + 150
VE-WT1U/S7-2100	Work Table with 1 U/S	2100 x 700 x 850 + 150
VE-WT1U/S7-2400	Work Table with 1 U/S	2400 x 700 x 850 + 150

700 SERIES

CODE	DESCRIPTION	DIMENSION (MM)
VE-WT2U/S7-900	Work Table with 2 U/S	900 x 700 x 850 + 150
VE-WT2U/S7-1050	Work Table with 2 U/S	1050 x 700 x 850 + 150
VE-WT2U/S7-1200	Work Table with 2 U/S	1200 x 700 x 850 + 150
VE-WT2U/S7-1350	Work Table with 2 U/S	1350 x 700 x 850 + 150
VE-WT2U/S7-1500	Work Table with 2 U/S	1500 x 700 x 850 + 150
VE-WT2U/S7-1800	Work Table with 2 U/S	1800 x 700 x 850 + 150
VE-WT2U/S7-2100	Work Table with 2 U/S	2100 x 700 x 850 + 150
VE-WT2U/S7-2400	Work Table with 2 U/S	2400 x 700 x 850 + 150

**Customisation available*

SINK UNIT / UNITS



WORK TABLE WITH SINK

600 SERIES

CODE	DESCRIPTION	DIMENSION (MM)
VE-WTS/S6-900	Work Table with SINK	900 x 600 x 850 + 150
VE-WTS/S6-1050	Work Table with SINK	1050 x 600 x 850 + 150
VE-WTS/S6-1200	Work Table with SINK	1200 x 600 x 850 + 150
VE-WTS/S6-1350	Work Table with SINK	1350 x 600 x 850 + 150
VE-WTS/S6-1500	Work Table with SINK	1500 x 600 x 850 + 150
VE-WTS/S6-1800	Work Table with SINK	1800 x 600 x 850 + 150
VE-WTS/S6-2100	Work Table with SINK	2100 x 600 x 850 + 150
VE-WTS/S6-2400	Work Table with SINK	2400 x 600 x 850 + 150

WORK TABLE WITH TWO SINK

600 SERIES

CODE	DESCRIPTION	DIMENSION (MM)
VE-2S/S6-900	2 SINK UNIT	900 x 600 x 850 + 150
VE-2S/S6-1050	2 SINK UNIT	1050 x 600 x 850 + 150
VE-2S/S6-1200	2 SINK UNIT	1200 x 600 x 850 + 150
VE-2S/S6-1350	2 SINK UNIT	1350 x 600 x 850 + 150
VE-2S/S6-1500	2 SINK UNIT	1500 x 600 x 850 + 150
VE-2S/S6-1800	2 SINK UNIT	1800 x 600 x 850 + 150
VE-2S/S6-2100	2 SINK UNIT	2100 x 600 x 850 + 150
VE-2S/S6-2400	2 SINK UNIT	2400 x 600 x 850 + 150

700 SERIES

CODE	DESCRIPTION	DIMENSION (MM)
VE-WTS/S7-900	Work Table with SINK	900 x 700 x 850 + 150
VE-WTS/S7-1050	Work Table with SINK	1050 x 700 x 850 + 150
VE-WTS/S7-1200	Work Table with SINK	1200 x 700 x 850 + 150
VE-WTS/S7-1350	Work Table with SINK	1350 x 700 x 850 + 150
VE-WTS/S7-1500	Work Table with SINK	1500 x 700 x 850 + 150
VE-WTS/S7-1800	Work Table with SINK	1800 x 700 x 850 + 150
VE-WTS/S7-2100	Work Table with SINK	2100 x 700 x 850 + 150
VE-WTS/S7-2400	Work Table with SINK	2400 x 700 x 850 + 150

700 SERIES

CODE	DESCRIPTION	DIMENSION (MM)
VE-2S/S7-900	2 SINK UNIT	900 x 700 x 850 + 150
VE-2S/S7-1050	2 SINK UNIT	1050 x 700 x 850 + 150
VE-2S/S7-1200	2 SINK UNIT	1200 x 700 x 850 + 150
VE-2S/S7-1350	2 SINK UNIT	1350 x 700 x 850 + 150
VE-2S/S7-1500	2 SINK UNIT	1500 x 700 x 850 + 150
VE-2S/S7-1800	2 SINK UNIT	1800 x 700 x 850 + 150
VE-2S/S7-2100	2 SINK UNIT	2100 x 700 x 850 + 150
VE-2S/S7-2400	2 SINK UNIT	2400 x 700 x 850 + 150

**Customisation available*



TWO TIER TROLLEY

CODE	DESCRIPTION	DIMENSION (MM)
VE-2TT	TWO TIER TROLLEY	900 x 600 x 900



THREE TIER TROLLEY

CODE	DESCRIPTION	DIMENSION (MM)
VE-3S/S6-900	THREE TIER TROLLEY	900 x 600 x 900



PLATFORM TROLLEY

CODE	DESCRIPTION	DIMENSION (MM)
VE-PT	PLATFORM TROLLEY	900 x 600 x 900



MARBLE WORK TABLE

CODE	DESCRIPTION	DIMENSION (MM)
VE-MWT	MARBLE TOP WORK TABLE	900 x 600 x 850



POT RACK

CODE	DESCRIPTION	DIMENSION (MM)
VE-PR	POT RACK	900 x 600 x 1800



POTATO AND ONION BINS

CODE	DESCRIPTION	CAPACITY
VE-BIN	POTATO AND ONION BINS	10-100 KG

FREEZED
REFRIGERATION DISPLAY

The art & Science of Keep-in Freeze



Cakes & Sweet Shops



CENTER HALL REFRIGERATED BUFFET DISPLAY UNIT



DROP IN-HOT WELL WITH SNEEZE GUARD
FVE-DHW-2/3/4/5



DROP IN-COLD WELL
FVE-DCW-2/3/4/5 GN



DROP IN-INDUCTION COOKING WOC WITH SNEEZE GUARD
FVE-ICW-300/450/600



DROP IN-FROST TOP
FVE-FT - 2/3 GN

OPEN DECK CHILLER AND COLD DISPLAY COUNTER

MODEL	FVE-DHW-3GN	FVE-ICW-450	FVE-DCW-3GN	FVE-FT-3GN
Capacity	1x1 3GN Pan	NA	1x1 3GN Pan	1x1 3GN Pan
Temperature (°C)	30-80	50-80 & 50-280	2-8	-0~+8
Electric Load	3kw	3+3 = 6kw	0.5kw	0.5kw
Voltage	220v/50Hz	220v/50Hz	220v/50Hz	220v/50Hz
Dimension (mm)	1100 x 635 x 450+600	1100 x 635 x 450+600	1100 x 635 x 450	1100 x 635 x 450
Refrigerant	NA	NA	R134a	R134a

FLOOR STANDING DISPLAYS



CM-ODC-1200/1500/1800



CM-DC-900/1200/1500

KEY FEATURES:

- Double tempered & special heated front glass that enhances visibility and prevents unhygienic condensation Auto defrost.
- Elegant combination of black glass & stainless steel.
- Contemporary LED lighting under each shelf.
- Ventilated refrigeration for uniform cooling.
- Digital temperature controller & display.
- Castors for easy mobility.



OPEN DECK CHILLER AND COLD DISPLAY COUNTER

MODEL	VE-DC-900	VE-DC-1200	VE-ODC-1500
Capacity	350L	500L	1000L
Temperature (°C)	2-8	2-8	2-8
Glass	Heated	Heated	Curtain
Shelves	2 & 3	2 & 3	6
Voltage	220v/50Hz	220v/50Hz	220v/50Hz
Dimension (mm)	900 x 730 x 1300	1200 x 730 x 1300	1500 x 750 x 1900



GLASS DISPLAY UNIT

MODEL	VE-THW-600 (HOT)	VE-TCC-600 (COLD)
Capacity	85	85L
Shelves	2	2
Temperature (°C)	40-65	2-8
Refrigerant	----	R134a/R600a
Rated Input Power (w)	1100	230/160
Overall Dimension (mm)	660 x 530 x 730	660 x 530 x 730



WINE CHILLER



- * Double temperature cabinets
- * Dynamic cooling
- * Inside fan for ventilation, achieving even temperature
- * #304 stainless steel glass door, one layer tempered for safety, anti-UV
- * Elegant blue LED inside light for illumination

- * Ball bearing sliding shelves
- * Digital controller with blue LED display & defrost timer
- * #304 stainless steel handle
- * Aluminum buttons



adjustable wood shelves



tempered glass door



inner LED light



self-evaporation water tray



digital control



lock fitted



Model	Dimension (mm)	Capacity	Bottle Capacity	Temperature	Power Consumption	Power Supply	No. of Shelves	Weight (kg)
CM-38	435×580×1020	125	35-50	3-22 °C	0.74KW.h/24h	220v/50Hz	7	46/43
CM-66	635×580×1020	190	66-80	3-22 °C	1KW.h/24h	220v/50Hz	7	56/53.5
CM-180	650×680×1840	480	181-210	3-22 °C	1.4KW.h/24h	220v/50Hz	8	117/112







BACK BAR BOTTLE COUNTER



RGB LED Lights Optional

- * Inside fan for ventilation, achieving even temperature
- * Inside light for illumination
- * Replaceable gasket for hygiene
- * Adjustable chrome shelves for merchandising
- * Carel digital controller with LED display & defrost timer
- * Embossed aluminum interior
- * Textured exterior body, avoids scratch
- * Elegant extruded handle
- * Double glazing, self-closing glass door, one layer tempered for safety
- * Inside drain hole, self-evaporation water tray, convenient
- * Available at various heights 90cm, 87cm and 84cm
- * With lock and key
- * 2 adjustable legs



-  adjustable wood shelves
-  self-evaporation water tray
-  tempered glass door
-  digital control
-  inner LED light
-  lock fitted

Model	Cooling System	Temp. Range	Volume	Product	Packages	Net	Gross
CM-100	Single Door	0~210 °C	130L	600x520x900	650x570x980	46	50
CM-200	Double Door	0~10 °C	210L	900-520x900	955x570x980	62	69
CM-300	Triple Door	0~10 °C	320L	1350x520x900	1400x570x980	82	90
CM-200S	Double Door	0~210 °C	210L	900x520x900	955x570x980	62	69
CM-300S	Triple Door	0~10 °C	320L	1350x520x900	955x570x980	82	90

UNDER COUNTER FREEZER/ REFRIGERATOR



TECHNICAL DATA

MODEL	: FVER1350L2
Exterior Dimensions (mm) W*D*H	: 1350*700*850
Net Volume (L)	: 260L
Temperature Range (°C)	: -2 ~ +10
Ambient Temperature (°C)	: 43(T)
Rated Power Input (W)	: 350
Refrigerant	: R134a
Cooling Type	: Ventilated
Defrosting Type	: Automatic



TECHNICAL DATA

MODEL	: FVEF1350L2
Exterior Dimensions (mm) W*D*H	: 1350*700*850
Net Volume (L)	: 260L
Temperature Range (°C)	: -15 ~ -22
Ambient Temperature (°C)	: 43(T)
Rated Power Input (W)	: 600
Refrigerant	: R400a
Cooling Type	: Ventilated
Defrosting Type	: Automatic



TECHNICAL DATA

MODEL	: FVER1350G
Exterior Dimensions (mm) W*D*H	: 1350*700*850
Net Volume (L)	: 260L
Temperature Range (°C)	: 0 ~ +10
Ambient Temperature (°C)	: 32(N)
Rated Power Input (W)	: 350
Refrigerant	: R134a
Cooling Type	: Ventilated
Defrosting Type	: Automatic



TECHNICAL DATA

MODEL	: FVER1800L3
Exterior Dimensions (mm) W*D*H	: 1800*700*850
Net Volume (L)	: 400L
Temperature Range (°C)	: -2 ~ +10
Ambient Temperature (°C)	: 43(T)
Rated Power Input (W)	: 360
Refrigerant	: R134a
Cooling Type	: Ventilated
Defrosting Type	: Automatic

UNDER COUNTER FREEZER/ REFRIGERATOR



TECHNICAL DATA

MODEL	: FVEF1800L3
Exterior Dimensions (mm) W*D*H	: 1800*700*850
Net Volume (L)	: 400L
Temperature Range (°C)	: -15 ~ -22
Ambient Temperature (°C)	: 43(T)
Rated Power Input (W)	: 700
Refrigerant	: R404a
Cooling Type	: Ventilated
Defrosting Type	: Automatic



TECHNICAL DATA

MODEL	: FVER1800G
Exterior Dimensions (mm) W*D*H	: 1800*700*850
Net Volume (L)	: 400L
Temperature Range (°C)	: 0 ~ +10
Ambient Temperature (°C)	: 32(N)
Rated Power Input (W)	: 360
Refrigerant	: R134a
Cooling Type	: Ventilated
Defrosting Type	: Automatic



TECHNICAL DATA

MODEL	: FVER2025D7PZ
Exterior Dimensions (mm) W*D*H	: 2025*800*990
Net Volume (L)	: 550L
Temperature Range (°C)	: 0 ~ +10
Ambient Temperature (°C)	: 43(T)
Rated Power Input (W)	: 360
Refrigerant	: R134a
Cooling Type	: Ventilated
Defrosting Type	: Automatic



TECHNICAL DATA

MODEL	: FVER1500PH
Exterior Dimensions (mm) W*D*H	: 1500*800*1070
Net Volume (L)	: 360L
Temperature Range (°C)	: 0 ~ +10
Ambient Temperature (°C)	: 43(T)
Rated Power Input (W)	: 360
Refrigerant	: R134a
Cooling Type	: Ventilated
Defrosting Type	: Automatic

UNDER COUNTER FREEZER/ REFRIGERATOR



TECHNICAL DATA

MODEL	: AS900
Exterior Dimensions (mm) W*D*H	: 900*700*850
Net Volume (L)	: 250L
Temperature Range (°C)	: 0 ~ +10
Ambient Temperature (°C)	: 32 (N)
Rated Power Input (W)	: 504
Refrigerant	: R134a
Cooling Type	: Ventilated
Defrosting Type	: Automatic



TECHNICAL DATA

MODEL	: GN1.2TN4	GN1.2BT4	GN1.2TNG4
Exterior Dimensions (mm) W*D*H	: 1400*820*2050	1400*820*2050	1400*820*2050
Net Volume (L)	: 1220L	1220L	1220L
Temperature Range (°C)	: -2 ~ +10	-15~ -22	0 ~ +10
Ambient Temperature (°C)	: 43 (T)	43(T)	32 (N)
Rated Power Input (W)	: 560	880	560
Refrigerant	: R134a	R404a	R134a
Cooling Type	: Ventilated	Ventilated	Ventilated
Defrosting Type	: Automatic	Automatic	Automatic



TECHNICAL DATA

MODEL	: GN550TN2	GN550BT2	GN550TNG2
Exterior Dimensions (mm) W*D*H	: 700*820*2050	700*820*2050	700*820*2050
Net Volume (L)	: 550L	550L	550L
Temperature Range (°C)	: 2 ~ +10	-10~ -22	0 ~ +10
Ambient Temperature (°C)	: 43 (T)	43 (T)	32 (N)
Rated Power Input (W)	: 350	750	350
Refrigerant	: R134a	R404a	R134a
Cooling Type	: Ventilated	Ventilated	Ventilated
Defrosting Type	: Automatic	Automatic	Automatic



TECHNICAL DATA

MODEL	: GN550TN2	BCF20	BCF40
Exterior Dimensions (mm) W*D*H	: 710*700*555	800*800*1000	800*800*1800
Net Volume (L)	: 60L	90L	230
Temperature Range (°C)	: -35 ~ +3	-35 ~ +3	-35 ~ +3
Ambient Temperature (°C)	: 43 (T)	32(N)	32(N)
Rated Power Input (W)	: 860	860	2400
Refrigerant	: R404a	R404a	R404a
Cooling Type	: Ventilated	Ventilated	Ventilated
Defrosting Type	: Automatic	Automatic	Automatic

TABLE TOP ITEMS



SINGLE GRILLER / JUMBO GRILLER
VE-CG-811 / VE-CG-811E



DOUBLE CONTACT GRILLER
VE-CG-813



ELECTRIC FRYER
VE-EF-6L (6/8/11 Ltr)



DOUBLE ELECTRICAL FRYER
VE-EF-6L2 (6/8/11 Ltr)



ELC. CONVEYOR TOASTER
VE-CT-150 (150/30/450)



POP-UP TOASTER
VE-ETS-4/6



ELECTRIC SALAMANDER
VE-937



AUTO LIFTED SALAMANDER
VE-AT-460



SHAWARMA MACHINE
VE-791/890

BAKERY RANGE

ROTARY OVEN

Can choose Electric & Gas
trolley Size 18 & 36 Tray

Baking a wide Range:

Bread, Toast, Cookies, Cakes, Etc.

- Efficient low-energy, super insulation.
- Overheating protection, safe and reliable.
- One operator can save manpower.
- Full Stainless Steel body.
- Computer control panel, simple to operate.
- Steam humidification function.
- Special Designed system to ensure uniform.
- Hot-air and temperature inside the oven.

Inside : 1.5mm thickness stainless steel;
Outside : 1.2mm thickness stainless steel
Schneider electronic accessories;
High Quality heating tube 135mm thickness.



ELECTRIC / GAS ROTARY OVER

MODEL	VE-RO-18 (E)	VE-RO-36 (E)	VE-RO-18 (G)	VE-RO-36 (G)
Voltage	380/3/50Hz or 380/3/60Hz	380/3/50Hz or 380/3/60Hz	380/3/50Hz or 380/3/60Hz	380/3/50Hz or 380/3/60Hz
Power	30.0kw	46.0kw	1.5kw	2.5kw
Gas	NA	NA	LPG/PNG	LPG/PNG
Temperature	RT 350 °C	RT 350 °C	RT 350 °C	RT 350 °C
Trolley	1	2	1	2
Tray	18	36	18	36
Net Weight (kg)	1600	3200	1600	2200
Dimension (L x D x H)	1800 x 1700 x 2400	2200 x 2000 x 2400	1800 x 1700 x 2400	2200 x 2000 x 2400

BAKERY RANGE

BAKERY RANGE

DOUGH SHEETER



FLOOR TYPE

TABLE TYPE

TECHNICAL DATA

MODEL	VE-DS-520B	VE-DS-520	VE-DS-650
Dimensions (LxWxH) mm	2080x880x620	2550x380x1180	2950x1100x1180
Working Position	2080/620	2550/1180	2950/1180
Maximum Roll Weight	5-7	5-7	6-8
Power (kw)	0.56	0.56	0.75
Conveyor Belt Size	2000x500	2000x500	2400x600
Voltage	220v-380v-50HZ-1/3HP		
Roller Adjust Gap	1-35mm	1-35mm	1-35mm

BREAD SLICER



TECHNICAL DATA

MODEL	VE-BS-31	VE-BS-39
Dimension (LxWxH)mm	630x630x685	675x630x740
Blade Frame Width (mm)	385	485
Output (pcs.)	240/per hr	240/per hr
Power (kw)	0.2	0.2
Thickness of Slice (mm)	12	12
Voltage (v)	220v-400v-50/60Hz-3HP	

PLANTARY OR PLANETARY MIXER WITH SAFETY GUARD



TECHNICAL DATA

MODEL VE-PM-Deluxe	200G	300G	400G
Dimensions (LxWxH) mm	460x440x810	580x500x995	580x500x1000
Capacity	20 Qt	30 Qt	40 Qt
Power (kw)	0.56	0.75	1.5
Rev/Min	92 / 176 / 337	87 / 174 / 337	87 / 174 / 337
Voltage (v)	220v-400v-50/60Hz-3HP		



S/S Whisk



S/S Bat



S/S Hook



TECHNICAL DATA

MODEL	VE-SM-50	VE-SM-75	VE-SM-90
Dimensions (LxWxH) mm	850x490x1070	940x540x1260	1000x540x1300
Dough Capacity (kg)	20	40	60
Floor Capacity (kg)	12.5	25	38
Bowl Capacity (Qt)	50	75	90
Power (kw)	2.25	2.25	3.75
Voltage (v)	220v-400v-50/60Hz-3HP		

SPIRAL MIXER



BAKERY RANGE

DOUGH DIVIDER



TECHNICAL DATA

MODEL	VE-MM-280
Dimensions (LxWxH) mm	1000 x 530 x 1060
Roller Working Width	280
Roller Size (mm)	95 x 280 (w)
Maximum Roll Weight	30-350g
Voltage/Power (v/kw)	220v-400v-50/60Hz-3HP

DOUGH DIVIDER / ROUNDER MACHINE



TECHNICAL DATA

MODEL	VE-DD-30	VE-DD-30A
Dimensions (LxWxH)mm	850 x 750 x 1500	850 x 750 x 1500
Dough Weight (g)	30-100	25-85
Power (kw)	0.75	0.75
Capacity / time	30pcs. / time	36pcs. / time
Net Weight (kg)	360	360

ELECTRIC OVEN SPECIFICATION

- Upturned glass door with Separate handles for hand protection.
- Separated controlling panel. easy for operation and time control.
- Visible glass widow to permit Real-time control of baking conditions.
- Efficient heating tube makes baking more balanced.
- Inner liner is made of plating aluminium plate, which is more durable and though under high temperature.
- Smoke - absorbing design for the hood to keep the whole machine more clean.
- Thicken insulation design to keep the heat inside.



TECHNICAL DATA

Model No.	MGE-2Y-4
Temperature Range	0-400 °C
Rated Voltage	380V
Rated Frequency	50Hz
Rated Power Input	9.96kW
Net Weight (kg)	355
Exterior Dimension (mm)	1260x1360x1780



BAKERY RANGE

BAKERY RANGE



BAKING OVEN / ELECTRIC DECK OVEN / INFRARED DECK OVEN / GAS DECK OVEN

TECHNICAL DATA

Model	Voltage (V)	Power (Kw)	Capacity	Dimensions (mm)	Chamber Size (mm)	Weight (kg)	Electric/Gas
VE-YXD-10C	220	3.2	1 Deck / 1 Tray	925x570x430	640x455x180	68	Electric
VE-YXD-20C	220/380	6.6	1 Deck / 2 Tray	1260x805x535	860x670x220	75	Electric
VE-YXD-40C	380	13.2	2 Deck / 4 Tray	1260x805x1100	860x670x220x2	135	Electric
VE-YXD-60C	380	19.8	3 Deck / 6 Tray	1260x805x1515	860x670x220x3	206	Electric
VE-YXD-13C	380	9	1 Deck / 3 Tray	1770x840x615	1300X670X220x3	105	Electric
VE-YXD-26C	380	18	2 Deck / 6 Tray	1700x805x1100	1300X670X220x6	190	Electric
VE-YXD-90C	380	25.2	3 Deck / 9 Tray	1700x805x1515	1300X670X220x9	290	Electric
VE-YXY-20A	220	0.1	1 Deck / 2 Tray	1330x840x615	860x670x220x2	99.5	LPG
VE-YXY-40A	220	0.2	2 Deck / 4 Tray	1330x840x1190	860x670x220x2	185	LPG
VE-YXY-60A	220	0.3	3 Deck / 6 Tray	1330x840x1660	860x670x220x3	256	LPG
VE-YXY-13A	220	0.1	1 Deck / 3 Tray	1770x840x615	1300X670X220x3	150	LPG
VE-YXY-26A	220	0.2	2 Deck / 6 Tray	1770x840x1190	1300X670X220x6	256	LPG
VE-YXY-90A	220	0.3	3 Deck / 9 Tray	1770x840x1660	1300X670X220x9	328	LPG
VE-NFD-40FF	380	1.2+3.5	0:4 Tray / P:8 Tray	1460x1190x1980	----	538	Electric

IMPORTED HEATING RANGE



SPST-780/11 GE CONVECTION OVEN

- Double boiling unit 4 and 3 x 8,5 kW
- Powerful brass burners with unique flame spreader
- Electric oven 4 x GN 1/1 with convection heat inside the cabinet

Index / code	Model	mm netto mm brutto	kg netto kg brutto	kW
117 260 148	SPST 780/11 GE	800 x 730 x 900 840 x 800 x	92,4 102,5	29,5 [G] 3,13 [E]



FTR 780 G GRIDDLE PLATE

- Ribbed
- 2 x 7 kW
- Self standing unit on a neutral cabinet, with door as an option
- Outstanding heat conduction of plate

Index / code	Model	mm netto mm brutto	kg netto kg brutto	kW
117 110 521	FTR 780 G	800 x 730 x 900 840 x 800 x 1080	90,1 100	14



GL 780 G LAVA STONE GRILL

- U-shape burner for large space coverage
- Piezzo ignition
- Fat-collecting drawer
- Removable splash guard

Index / code	Model	mm netto mm brutto	kg netto kg brutto	kW
117 130 168	GL 780 G	800 x 730 x 1020 860 x 820 x 1120	71 85	15



SPQT 780/11 E RANGE WITH STATIC OVEN

- Double boiling unit with square plates 4 x 2,6 kW
- Power control enabled by 6-position regulation switch knob
- Electric oven 4xGN 1/1 with Convection heat inside the cabinet

Index / code	Model	mm netto mm brutto	kg netto kg brutto	kW
117 260 152	SPQT 780/11 E	800 x 730 x 900 840 x 800 x 1080	92 105	13,5

IMPORTED HEATING RANGE

Pending



SPL 780 E

BOILING TOP

- Double boiling unit 4 x 3 kW on a neutral cabinet, with doors as an option
- Internal thermostatic protection inside each plate
- Pressed upper plate for comfortable maintenance

Index / code	Model	mm netto mm brutto	kg netto kg brutto	kW
117 260 157	SPL 780 E	800 x 730 x 900 840 x 800 x 1080	94,7 105	12



VT 780 E

ELECTRIC PASTA COOKER

- Option of basket configuration to be defined with order
- Water drainage into the water
- Resistance made of resistant material Incoloy 820
- Volume of basins 2 x 23 litres

Index / code	Model	mm netto mm brutto	kg netto kg brutto	kW	Basin/Tank
117 330 039	VT 780 E	800 x 730 x 900 840 x 800 x 1080	74,9 85	15	2x 340 x 306 x 329



SPI 780 ES

INDUCTION HOB

- Double EXTRA POWER induction hob on a cabinet
- Berner induction components
- High efficiency and ultimate speed of operation
- Plate diameter 120 - 230 mm

Index / code	Model	mm netto mm brutto	kg netto kg brutto	kW
117 261 032	SPI 780 ES	800 x 730 x 900 860 x 820 x 1080	94 108	20



FE 740/13 E

ELECTRIC FRYER 13 L

- Self standing unit on a neutral cabinet
- Option of 1 large basket or 2 medium baskets / 1 basin to be defined with order
- High power output/oil volume ratio

Index / code	Model	mm netto mm brutto	kg netto kg brutto	kW	Basket
117 090 032	FE 740/13 E	400 x 730 x 900 440 x 800 x 1080	45,3 51,5	9,9	215 x 300

IMPORTED HEATING RANGE



FE 780/13 E

ELECTRIC FRYER 2X13 L

- Self standing unit on a neutral cabinet
- Option of 1 large basket or 2 medium baskets / 1 basin to be defined with order
- High power output/oil volume ratio

Index / code	Model	mm netto mm brutto	kg netto kg brutto	kW	Basket
117 090 019	FE 780/13 E	800 x 730 x 900 840 x 800 x 1080	77,4 87,5	19,8	215 x 300



FE 740/17 G

GAS FRYER 17 L

- Self standing unit on a neutral cabinet
- Option of 1 large basket or 2 medium baskets / 1 basin to be defined with order
- High power output/oil volume ratio

Index / code	Model	mm netto mm brutto	kg netto kg brutto	kW	Basket
117 090 651	FE 740/17 G	400 x 730 x 900 440 x 800 x 1080	42 52	14	280 x 300



FE 780/17 G

GAS FRYER 2X17 L

- Self standing unit on a neutral cabinet
- Option of 1 large basket or 2 medium baskets / 1 basin to be defined with order
- High power output/oil volume ratio

Index / code	Model	mm netto mm brutto	kg netto kg brutto	kW	Basket
117 090 658	FE 780/17 G	800 x 730 x 900 840 x 800 x 1080	59 69	28	280 x 300



BR 780 E/N

TILTING BRATT PAN 50 L

- Manual tilt
- Tank made of AISI 304, thickness of bottom 12 mm
- High thermic conduction

Index / code	Model	mm netto mm brutto	kg netto kg brutto	kW
117 030 149	BR 780 E/N	800 x 730 x 900 840 x 800 x 1080	153,2 163,5	10,5

IMPORTED HEATING RANGE



BR 780 G/N

TILTING BRATT PAN 50 L

- Manual tilt
- Tank made of AISI 304, thickness of bottom 12 mm
- High thermic conduction

Index / code	Model	mm netto mm brutto	kg netto kg brutto	kW
117 030 178	BR 780 G/N	800 x 730 x 900 840 x 800 x 1080	159,2 169,5	12



BRM 780 E/N

TILTING BRATT PAN 50 L

- Motorized tilt
- Tank made of AISI 304, thickness of bottom 12 mm
- High thermic conduction

Index / code	Model	mm netto mm brutto	kg netto kg brutto	kW
117 030 088	BRM 780 E/N	800 x 730 x 900 840 x 800 x 1080	157,4 167,5	10,5



BRM 780 G/N

TILTING BRATT PAN 50 L

- Motorized tilt
- Tank made of AISI 304, thickness of bottom 12 mm
- High thermic conduction

Index / code	Model	mm netto mm brutto	kg netto kg brutto	kW
117 030 179	BRM 780 G/N	800 x 730 x 900 840 x 800 x 1080	163,4 173,5	12



BI 780 E

BOILING KETTLE 50 L

- Indirect heat
- Ergonomic lid handle for safe tank opening
- Massive drain tap with conical sealing

Index / code	Model	mm netto mm brutto	kg netto kg brutto	kW
--------------	-------	-----------------------	-----------------------	----

IMPORTED HEATING RANGE



BIA 90/150 E/G BOILING KETTLE 150 L

- Highly effective indirect heating system
- Ergonomic lid handle for safe tank opening
- Semi-automatic water filling system
- Discharge valve with conical sealing
- Autoclave

Index / code	Model	mm netto mm brutto	kg netto kg brutto	kW
106 000 555	BIA 90/150 E	800 x 900 x 900 840 x 970 x 1160	130,5 145,4	21
106 000 655	BIA 90/150 G	800 x 900 x 900 840 x 970 x 1160	150,1 165	22,5



BR 90/120 E/G TILTING BRATT PAN 120 L

- Easy manual tilt
- Tank made of cast iron, thickness 12 mm with high thermic conduction

Index / code	Model	mm netto mm brutto	kg netto kg brutto	kW
106 000 263	BR 90/120 E/N	1200 x 900 x 900 1240 x 970 x 1170	176,4 196,1	18
106 000 273	BR 90/120 G/N	1200 x 900 x 900 1240 x 970 x 1170	183,5 203,2	30



BRM 90/120 G/N TILTING BRATT PAN 120 L

- Highly convenient motorized tilt
- Tank made of cast iron, thickness 12 mm with high thermic conduction

Index / code	Model	mm netto mm brutto	kg netto kg brutto	kW
106 000 278	BRM 90/120 G/N	1200 x 900 x 900 1240 x 970 x 1170	188 207,7	30 [G] 0,12 [E]





BRINGING YOUR FOOD WITH CARE

With ScanBox you will have a partner who loves food and is passionate about creating the best solutions for every place of work. We strive to facilitate your working day and enhance the experience of your guests – be it a star-spangled Michelin restaurant, a hotel or a school canteen.



Ergo Line Hot

Item number	111211-9
Capacity	GN 1/1 65 mm 12 runners
Measurements	W540 x H1440 x D810 mm
Weight	58 kg
Connection	220V-240V/ 1 phase/50Hz
Consumption	W/A 570/2,7



Ergo Line Active Cooling

Item number	131211-5
Capacity	GN 1/1 65 mm 12 runners
Measurements	W540 x H1440 x D810 mm
Weight	65 kg
Connection	220V-240V/ 1 phase/50Hz
Consumption	W/A 340/1,64



Ergo Line Combo Active Cooling + Hot

Item number	172003-1
Capacity	GN 1/1 65 mm 4 + 6 runners
Measurements	W540 x H1445 x D810 mm
Weight	69 kg
Connection	220V/ 1 phase/50Hz
Consumption	W/A 190+460/3



Ergo Line Duo Active Cooling + Hot

Item number	180304-4
Capacity	GN 1/1 65 mm 12 + 12 runners
Measurements	W1100 x H1390 x D810 mm
Weight	112 kg
Connection	220V-240V/ 1 phase/50Hz
Consumption	W/A 340+570/4,1



DISHWASHING



SPEED UP!

The new C50. A modular system for high capacity.

PRODUCT FEATURES C50

- LANGUAGE-NEUTRAL DISPLAY
- HIGHTEMP
- FAST DRAINAGE AND FILLING
- DOUBLE FILTRATION
- PUMP RINSE
- ZONE ACTIVATION
- NON-PRESSURIZED BOILER
- EFFICIENT TANK HEATING

AVAILABLE : UNDERCOUNTER | GLASSWASHER | HOOD TYPE



General data		C50 Single rinse	C50 Dual rinse
Tank capacity (rinse tank)	l	95	95 (12.5)
Rack dimension	mm	500 x 500	500 x 500
Clear entry height	mm	450	450
Passage width	mm	510	510
Working height (optional)	mm	900 (950)	900 (950)
Wash pump	kW	1.6	1.6
Noise emission	dB(A)	< 70	< 70
Splash guard		IPX5	IPX5



HOOD TYPE-P50



UNDERCOUNTER-U50



GLASSWASHER-G400

DISHWASHING

The Electrolux dishwashing range is produced for customers with the highest conceivable demands for Good efficiency, economy and ergonomics for dishwashing operation. The product range consists on Glasswashers, Undercounter Dishwashers, Hood Type Dishwashers, Rack type Dishwashers, Flight type dishwashers.



UNDERCOUNTER



GLASSWASHER



RACK TYPE DISHWASHER



HOOD TYPE DISHWASHER



PROFESSIONAL WAREWASHING, CLEANING AND DISINFECTION TECHNOLOGY



**Upster KS 200
RACK TYPE DISHWASHING MACHINE**



**Upster H 500
PASS-THROUGH DISHWASHING MACHINE**



IMPORTED PRE-RINSE UNIT

Continuing to set Quality Standards for over 70 years

T&S Quality Policy: The employees of T&S Brass and Bronze will provide high quality solutions to the food service, plumbing, and institutional markets while providing exceptional customer service and striving to continuously improve the effectiveness of the Quality Management System.



Model : EX-1DP00-H

Product Specifications:

Pre-Rinse Unit: Single Lever Deck Mount Faucet, 24" Riser, 2 Saddleback Cove / P.O. Box 1088 44" Flexible Stainless Steel Hose, 5SV-H High Flow Spray Valve, Travelers Rest, SC 29690 6" Wall Bracket 18" Flexible Steel Supply Hoses w/Check Valves



Model : EX-6WP00-H

Product Specifications:

Pre-Rinse Unit: Single lever Wall Mount Base Faucet, 18" Riser, 44" Flexible 2 Saddleback Cove/P.O. Box 1088 Stainless Steel Hose, High Flow Spray Valve, 6" Wall Bracket & G 1/2" Male Inlets



Model : EX-1DP12-H

Product Specifications:

Pre-Rinse Unit: Single Lever Deck Mount Faucet, Add-On Faucet, 12" Swing Nozzle, 18" Riser, 44" Flexible Stainless Steel Hose, 5SV-H High Flow Spray Valve, 6" Wall Bracket, 18" Flexible Supply hoses w/ Check Valves



Model : EX-6WP12-H

Product Specifications:

Pre-Rinse Unit: Single Lever Wall Mount Base Faucet, Add-On 2 Saddleback Cove / P.O. Box 1088 Faucet, 12" Swing Nozzle w/ Full Flow Aerator, 18" Riser, 44" Flexible Stainless Steel Hose, High Flow Spray Valve & 6" Wall Bracket



Model : B-0113

Product Specifications:

Pre-Rinse Unit : EasyInstall Single Hole Deck Mount Mixing Faucet, Quarter-Turn Eterna Cartridges w/Spring Checks, Lever Handles, 44" Flexible Stainless Steel Hose, 1.15 GPM Spray Valve, 6" Wall Bracket & Flexible Stainless Steel Supply Hoses



Model : B-0133

Product Specifications:

Pre-Rinse Unit: EasyInstall 8" Wall Mount Mixing Faucet, Quarter-Turn Eterna Cartridges w/ Spring Checks, Lever Handles, 44" Flexible Stainless Steel Hose, 1.15 GPM Spray Valve, 6" Wall Bracket & 1/2" NPT Female Inlets

Model : 5HR-242-01

Hose Reel, Open, Powder Coated Steel, 50' x 3/8" ID Hose with Spray Valve

Features & Benefits :

Open coated hose reel
Black high flow spray valve
3/8" x 50' hose
Ratcheting system holds the length of hose until a slight tug to retract automatically 3/8" NPT female inlet
Adjustable hose bumper
Multi-fit bracket for wall, ceiling or under counter mounting

Details :

Box Dimensions: 23x21x9
Weight: 55.00 lbs (24.95 kg)
UPC: 671262581967, Harmonize: 8424.20.0000

Model : 5HR-232-01

Hose Reel, Open, Powder Coated Steel, 35' x 3/8" ID Hose with Spray Valve

Features & Benefits :

Open coated hose reel
Black high flow spray valve
3/8" x 35' hose
Ratcheting system holds the length of hose until a slight tug to retract automatically
3/8" NPT female inlet Adjustable hose bumper
Multi-fit bracket for wall, ceiling or under counter mounting

Details :

Box Dimensions: 19x16x7.5
Weight: 34.05 lbs (15.44 kg)
UPC: 671262581912
Harmonize: 8424.20.0000



IMPORTED DISHWASHING



5F-1SLX05
Faucet, Single Hole, 5-1/2" Swivel Gooseneck

Product Specifications:
Single Supply Deck Mount Faucet w/ Ceramic Cartridge, equip Lever Handle, 5 1/2" equip Swivel Gooseneck & 1/2" NPSM Male Inlet

Details :
Box Dimensions: 14x9x4
Weight: 2.85 lbs (1.29 kg)
UPC: 671262593700
Harmonize: 8481.80.5060

5F-4CWX12
Equip 4" c/c Deck Mount Workboard Fct w/12" Swing Nozzle, 4" Wrist Action Handles



Architect/Engineering Specifications:

4" deck mount mixing faucet with polished chrome plated brass body, 12" swing nozzle with laminar flow device, ceramic cartridges, equip 4" wrist action handles and 1/2" NPT male inlets.

5F-8DLX12
Faucet, 8" Centers, Deck Mount, 12" Swing Nozzle



Specifications:
8" Deck Mount Mixing Faucet, Ceramic Cartridges, equip Lever Handles, 12" equip Swing Nozzle & 1/2" NPT Female Inlets

5F-8DLX05
Faucet, 8" Centers, Deck Mount, 5" Spout



Product Specifications:
8" Deck Mount Mixing Faucet w/ Quarter-Turn Ceramic Cartridges, equip Lever Handles, 5 1/2" equip Swivel Gooseneck & 1/2" NPT Female Inlets

5F-8WLX12
Faucet, Wall Mount, 8" Centers, 12" Swing Nozzle



Specifications:
8" Wall Mount Mixing Faucet, Ceramic Cartridges, equip Lever Handles, 12" equip Swing Nozzle & 1/2" NPT Female Inlets

5F-8WLX05
Faucet, Wall Mount, 8" Centers, 5-1/2" Swivel Gooseneck



Product Specifications:
8" Wall Mount Mixing Faucet w/ Ceramic Cartridges, equip Lever Handles, 5 1/2" equip Swivel Gooseneck & 1/2" NPT Female Inlets

Model : B-3950
Waste Drain Valve, Twist Handle, 3-1/2" x 2" & 1-1/2" Adapter



Product Specifications:
Rotary Waste Valve w/ Twist Handle, 3 1/2" Sink Opening, 2" NPT Male Outlet & 1 1/2" NPT Male Adapter

Model : B-2282-01
Dipperwell Faucet & Bowl Assembly



Product Specifications:
Dipperwell Faucet w/ Drain, Stainless Steel Bowl & Inner Overflow Cup

The SelfCookingCenter® India Edition.

Easy to use, makes healthy and delicious food, saves money.

Our motivation was and is to make working in a food-service kitchen as easy as possible. That is why we have equipped the new SelfCookingCenter® India Edition with four intelligent functions and turned it into an assistant that stands for quality, ease of use and efficiency.

2 year warranty



The right appliance for every need.



Appliances	XS Model 6 2/3	Model 61	Model 101	Model 201	Model 202
Electric and gas					
Capacity	6 × 2/3 GN	6 × 1/1 GN	10 × 1/1 GN	20 × 1/1 GN	20 × 2/1 GN
Number of meals per day	20–80	30–100	80–150	150–300	300–500
Lengthwise loading	1/2, 2/3, 1/3, 2/8 GN	1/1, 1/2, 2/3, 1/3, 2/8 GN	1/1, 1/2, 2/3, 1/3, 2/8 GN	1/1, 1/2, 2/3, 1/3, 2/8 GN	2/1, 1/1 GN
Width	655 mm	847 mm	847 mm	879 mm	1,084 mm
Depth	555 mm	776 mm	776 mm	791 mm	996 mm
Height	567 mm	782 mm	1,042 mm	1,782 mm	1,782 mm
Water inlet	R 3/4"	R 3/4"	R 3/4"	R 3/4"	R 3/4"
Water outlet	DN 40	DN 50	DN 50	DN 50	DN 50
Water pressure	150–600 kPa or 0.15–0.6 Mpa	150–600 kPa or 0.15–0.6 Mpa	150–600 kPa or 0.15–0.6 Mpa	150–600 kPa or 0.15–0.6 Mpa	150–600 kPa or 0.15–0.6 Mpa
Electric					
Weight	72 kg	110 kg	135 kg	268 kg	351 kg
Connected load	5.7 kW	11 kW	18.6 kW	37 kW	65.5 kW
Fuse	3 × 10 A	3 × 16 A	3 × 32 A	3 × 63 A	3 × 100 A
Mains connection	3 NAC 400 V	3 NAC 400 V	3 NAC 400 V	3 NAC 400 V	3 NAC 400 V
Convection mode output	5.4 kW	10.3 kW	18 kW	36 kW	64.2 kW
Steam mode output	5.4 kW	9 kW	18 kW	36 kW	54 kW
Gas					
Weight	–	123 kg	152 kg	299 kg	381 kg
Height incl. draft diverter	–	1,012 mm	1,272 mm	2,087 mm	2,087 mm
Electrical rating	–	0.3 kW	0.39 kW	0.7 kW	1.1 kW
Fuse	–	1 × 16 A	1 × 16 A	1 × 16 A	1 × 16 A
Mains connection	–	1 NAC 230 V	1 NAC 230 V	1 NAC 230 V	1 NAC 230 V
Gas supply/connection	–	R 3/4"	R 3/4"	R 3/4"	R 3/4"
Natural gas/Liquid gas 3B/P					
Max. nominal thermal load	–	13 kW/13 kW	22 kW/22 kW	44 kW/44 kW	90 kW/90 kW
Convection mode output	–	13 kW/13 kW	22 kW/22 kW	44 kW/44 kW	90 kW/90 kW
Steam mode output	–	12 kW/13 kW	20 kW/22 kW	38 kW/40 kW	51 kW/56 kW

XS and Model 202 electric: ENERGY STAR excludes these appliance features from certification

PIZZA OVEN PZ 430 D

The professional pizza oven PZ 430 D is equipped with an innovative system: a double temperature control. This very compact infrared oven can cook a wide variety of pizzas and dishes in record time.

TECHNICAL DATA :

Inside dimensions	: 2x(430 x 430 x 110 mm)
Power	: 5 kW or 3 kW (with 2 cords)
Outside dimensions	: 670 x 580 x 500 mm
Weight	: 55 kg
volts	: 380 V ou 230 V mono
Capacity	: 2 pizzas Ø 41 cm (16")



GAS GYROS GRILL – 800-MM-HIGH SPIT - 40 KG OF MEAT

The gyros grill or kebab grill GR 80 G fits all your dishes of gyros or kebab meat. This vertical gas grill has been designed for easy use and maintenance.

TECHNICAL DATA :

Capacity	: 40 kg
Power	: 14 kW
Dimensions	: 580 x 660 x 1035 mm
Weight	: 38 kg
Spindle height	: 800 mm



PROFESSIONAL ELECTRIC WAFFLE IRON – GES 20/10

The professional electric waffle iron Liège GES 20 is one of the essential waffle makers for classic Belgian waffles!

TECHNICAL DATA : (MODEL GES 20)

Waffle Size	: 100 x 180 x 26 mm
Power	: 1.6 kW
Dimensions	: 305 x 440 x 230 mm
Weight	: 22 kg
volts	: 230 V

TECHNICAL DATA : (MODEL GES 10)

Waffle Size	: 00 x 170 x 22 mm
Power	: 1.6 kW
Dimensions	: 305 x 440 x 230 mm
Weight	: 22 kg
volts	: 230 V



CAST-IRON CONTACT GRILL – SPECIFIC MODEL FOR SANDWICHES

The cast-iron contact-grill PANINI and SAVOYE is the indispensable professional equipment for intensive use in fast-food restaurants. Its specifications are particularly recognized in professional catering.

TECHNICAL DATA : (PANINI)

Power	: 2 kW
Coating	: Fonte Brute
Outside dimensions	: 430 x 385 x 220 mm
Baking surface	: 360 x 240 mm
Weight	: 24 kg
volts	: 230 V

TECHNICAL DATA : (SAVOYE)

Cooking surface	: 260 x 240 mm
Outside dimensions	: 330 x 385 x 220 mm
Weight	: 19 kg
volts	: 230 V
Power	: 2 kW
Coating	: Fonte brute



PANINI



SAVOYE



Basic Bar Blenders

TECHNICAL SPECIFICATIONS		
Model No.	Bb250	BB250S
Speed (hp)	½ motor	½ motor
Revolutions (r.p.m.)	22,000	22,000
Capacity (lt.)	1.4	1
Power Supply (hz)	230 VAC, 50/60	230 VAC, 50/60



Hi-Power Blenders

TECHNICAL SPECIFICATIONS		
Model No.	MX1000TXEE	MX1000XTPE
Speed (hp)	¾ motor	¾ motor
Revolutions (r.p.m.)	32,000	32,000
Capacity (lt.)	2	1.4
Power Supply (hz)	230 VAC, 50/60	230 VAC, 50/60



2-Liter Reprogrammable Hi-Power Blenders

TECHNICAL SPECIFICATIONS		
Model No.	MX1500TXSEE	MX1500XTPEE
Speed (hp)	¾ motor	¾ motor
Power (w)	1500	1500
Capacity (lt.)	2	1.4
Power Supply (hz)	230 VAC, 50/60	230 VAC, 50/60



Heavy-Duty Single/Double Belgian Waffle Makers

TECHNICAL SPECIFICATIONS		
Model No.	WW180E	WW200E
Belgian Waffles (per hour)	25	50
Power Supply (hz)	230 VAC, 50	230 VAC, 50



Commercial Knife Sharpener

TECHNICAL SPECIFICATIONS	
Model No.	WKS800E
Grinds Angles	18-22°
Power Supply (hz)	230 VAC, 50/60



Heavy-Duty Juice Extractor With Pulp Ejection

TECHNICAL SPECIFICATIONS		
Model No.	JEX450E	
Large (cm)	7.5	
Power (w)	1 + hp, 1000	
Power Supply (hz)	230 VAC, 50/60	



Built In Food Warmer



Carving Station



Decorative Lamps



Pop-Up Commercial Toasters



Toast-Rite® Conveyor Toasters (TRH)



Toast-Quik® Conveyor Toasters



Flav-R-Fresh® Impulse Display Cabinets



VEGETABLE CUTTER



BOWL CUTTER



HAND HELD MIXER



CITRUS JUICERS



DRINK MIXERS



BAR BLENDERS



MEAT GRINDERS



MEAT SLICER

sammic

Dynamic Food Preparation Best Quality Food Preparation Equipment



SLICER-CUTTER



POTATO PEELER



HAND HELD MIXER



BAR BLENDERS



KNIFE STERILISER



MEAT GRINDER



MEAT GRINDER



MEAT SLICER

ROBOT-COUPÉ, THE FOOD PREPARATION SPECIALIST

VEGETABLE CUTTER | FOOD CUTTER | STICK BLENDER | JUICER | BLIXER



HEAVY DUTY COMMERCIAL JUICERS



Silent and powerful juice extractor to use everywhere you need fresh fruits and vegetables juices: juice bars, health food stores, hotels, bars, restaurants...



CENTRIFUGAL JUICE EXTRACTOR #50

MOTOR
Single Phase
100 - 120 V - 50/60 Hz - 800 W
220 - 240 V - 50/60 Hz - 800 W

SPEED
3000 rpm (50 Hz)
3600 rpm (60 Hz)

WEIGHT
Net: 14.5 kg (31 lbs)
Packed: 16.3 kg (35 lbs)

DIMENSIONS
Net
D: 470 mm (19")
W: 260 mm (10")
H: 450 mm (18")

PACKED
D: 500 mm (20")
W: 315 mm (12")
H: 570 mm (22")

CITRUS JUICER #11

MOTOR
Single Phase
100 - 120 V - 50/60 Hz - 155 W
220 - 240 V - 50/60 Hz - 130 W

SPEED:
1500 rpm (50 Hz)
1800 rpm (60 Hz)

WEIGHT
Net: 4.9 kg (11lbs)
Packed: 5.7 kg (12lbs)

DIMENSIONS
Net
D: 300 mm (12")
W: 230 mm (9")
H: 350 mm (14")

PACKED
D: 340 mm (13")
W: 255 mm (10")
H: 400 mm (16")

MADE IN ITALY

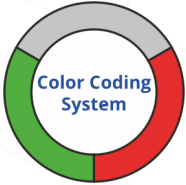

"U" DESIGN

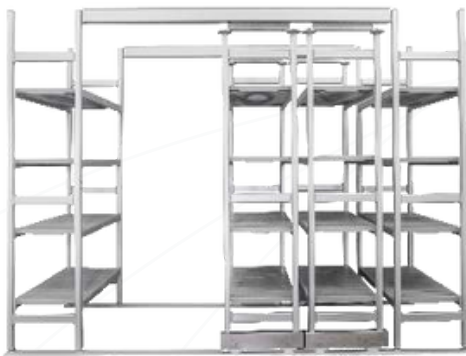

DISPLAY TROLLEYS

Whether you're starting a restaurant, needing to replace your existing ice machine, or deciding to add an additional ice machine to your operation, consider Koolaire by Manitowoc. Koolaire ice machines provide you with basic features you need with the reliability you expect at a price that fits your budget.

EASY TO CLEAN AND MAINTAIN

Getting in and out fast for service and cleaning cansave time and money. Access is easy on a Koolaire with the removal of just two screws and an easy to lift-off door.

Koolaire features a high-tech, smudge and fingerprint-resistant stainless-like finish that's easy to clean and maintain. Koolaire uses white plastics in the food zone making it easy to see exactly what areas need to be cleaned.

Parts that need cleaning can be removed without tools. The water shield, distribution tube, pump, floats, and even the trough can be removed by hand.

Optional CleanAir packs control the growth of bacteria and fungi that form slime and cause odors in the food zone.



Air Flow Front View



Extraclean air not right inside area.

Air Filter



Slide out filter with side front without tools. Easy to clean, wash or filter perfectly condition here again and again.

Easy Access Door



Easy access door, slide up and out of the way.

Quiet by nature, the Sotto undercounter ice machine puts quality ice where you need it most.



Sized right for your operation.



	UG-20	UG-30	UG-40	UG-50	UG-65	UG-80
Ice Production¹ (kg)	22	31	45	55	67	86
Ice Storage Capacity (kg)	5.5	5.5	14	14	30	30
Width (cm)	45	45	55	55	70	70
Depth (cm)	47.5	47.5	55	55	60	60
Height (cm)	65	65	80	80	90	90

¹Kilograms produced per day. Approximate ice-making capacity based on air-cooled condenser unit at 21°C air and 10°C water.

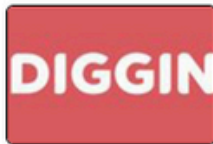
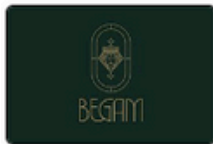

ASSOCIATE PARTNER





Contact

Phone: +91 888-299-8389, +91 981-116-2606

info@vinaayakenterprises.com

www.vinaayakenterprises.com